

Lane

ZOOLOGY & ORNITHOLOGY

SPECIMEN CABINETS



The Lane Zoology & Ornithology specimen cabinets are designed for the proper and permanent protective storage of bird and animal skins.



PERMANENT SPECIMEN PROTECTION

Lane

SCIENCE EQUIPMENT CORP.

MODEL 201 FOR LARGE SKINS

The 201 Model for large skins is designed for the use of large specimen trays.

Dimensions
 Height 42 1/16"
 Width 46 1/2"
 Depth 28 1/32"

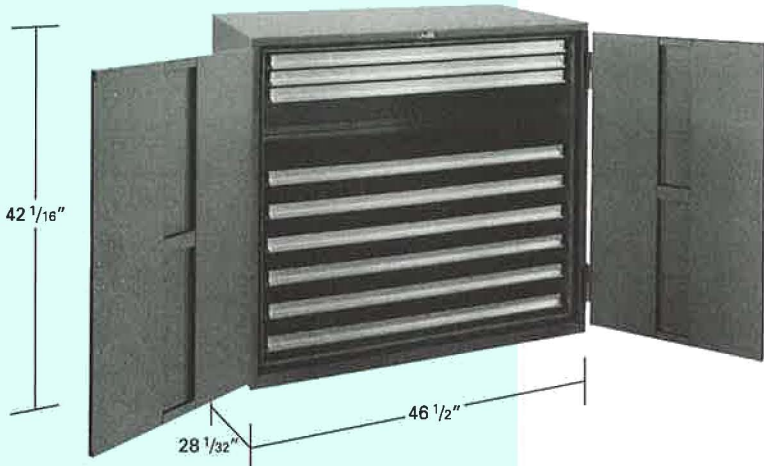

LARGE SIZE TRAY—HIGH RIM
#201-T (MASONITE/ALUMINUM)
#201-T/S (STEEL)
 Height 3 1/2"
 Width 42 3/8"
 Depth 26"
 9 Tray Maximum Capacity



LARGE SIZE TRAY—LOW RIM
#201 1/2-T (MASONITE/ALUMINUM)
#201 1/2-T/S (STEEL)
 Height 1 5/8"
 Width 42 3/8"
 Depth 26"
 18 Tray Maximum Capacity

MODEL 202 FOR SMALL SKINS

The 202 Model for small skins is engineered for the use of smaller trays, divided by a center conversion section. The overall size is the same as Model #201.

Dimensions
 Height 42 1/16"
 Width 46 1/2"
 Depth 28 1/32"

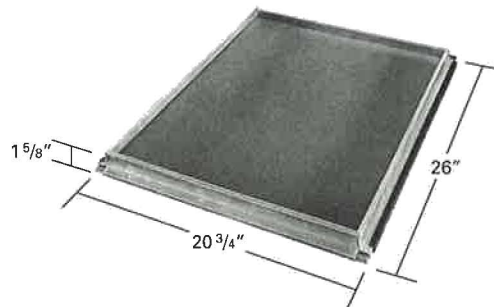
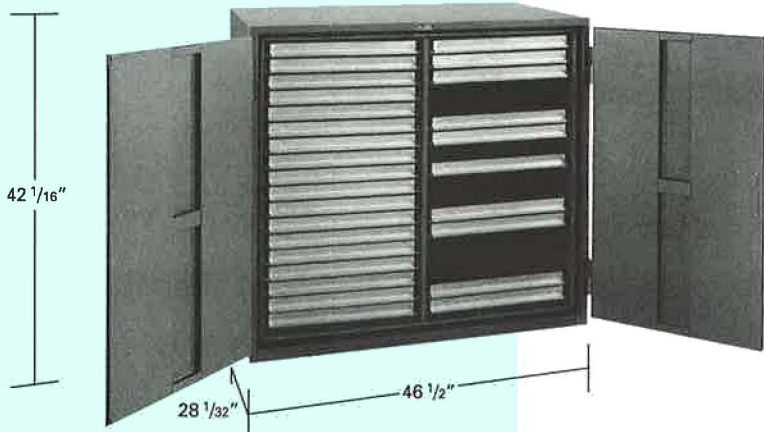

SMALL SIZE TRAY
#202-T (MASONITE/ALUMINUM)
#202-T/S (STEEL)
 Height 1 5/8"
 Width 20 3/4"
 Depth 26"
 36 Tray Maximum Capacity
 18 Maximum Trays in Each Section

Price of cabinets does not include trays; trays must be ordered separately.

CONSTRUCTION FEATURES TO PROTECT YOUR COLLECTION

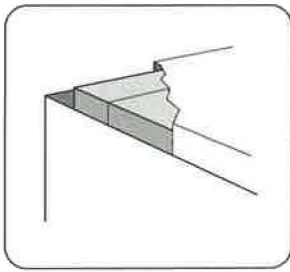

DOUBLE WALL CONSTRUCTION
All welded double wall construction assures rigidity and durability.

ELASTOMERIC DOOR SEAL
• No adhesives

LIFT-OFF DOOR WITH SLIP TYPE HINGE
13 gauge steel, safe-type design and size permit easy removal and replacing of the door. This type of door is extremely useful when mass transference of specimens is to take place.

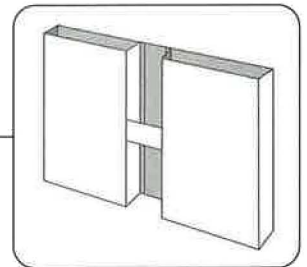
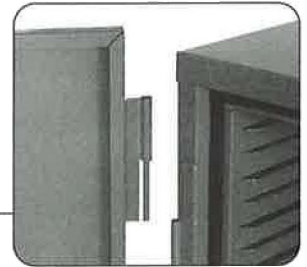

DOUBLE PANELED DOOR
Assures complete and total contact with airtight seal.

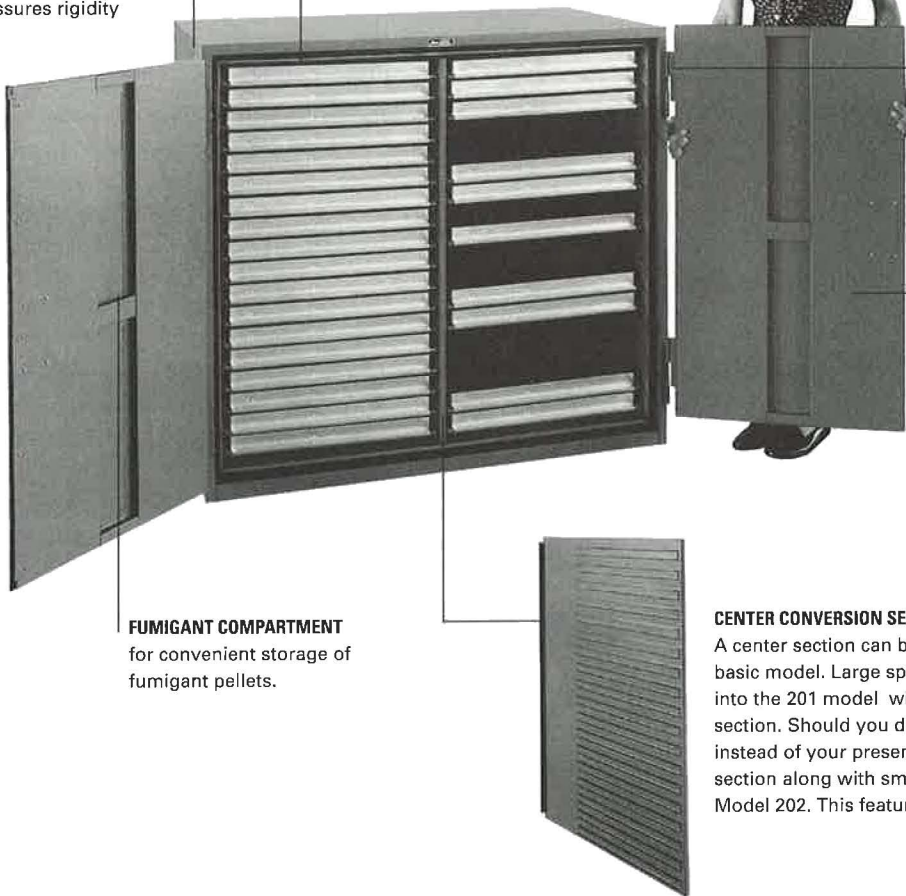

FUMIGANT COMPARTMENT
for convenient storage of fumigant pellets.

CENTER CONVERSION SECTION—200CD

A center section can be added or removed to this basic model. Large specimen trays can be inserted into the 201 model without the center conversion section. Should you desire a double case (202 model) instead of your present 201 model, simply order this section along with smaller trays and you have the Model 202. This feature affords maximum flexibility!

MAXIMUM FLEXIBILITY

TRAYS

- Trays are available with a natural aluminum frame and masonite bottom or, with all steel construction.
- Aluminum/masonite trays are light weight, yet rigid and are unpainted.
- Steel trays are rigid and have powder paint finish.

All trays feature:

- Plastic runners with rigid polystyrene edges
- Built in label holder
- Ease of operation

CABINETS

- Lane cabinets 201 and 202 skin cases can be stacked to maximize storage space.
- They can be placed in a row and used as a work counter.
- And, they can be converted from one model to the other by adding or deleting the center conversion section.

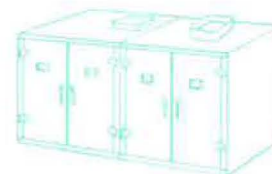

Placed in a row and used as a work counter.

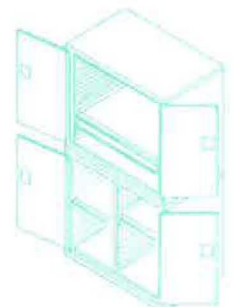

Model 201 over 202



S C I E N C E E Q U I P M E N T C O R P .

**OTHER LANE
SPECIMEN CABINETS**



HERBARIUM

Cabinets for the storage of
botanical specimens



GEOLOGY & PALEONTOLOGY

Cabinets for storage of rock and
fossil collections



ENTOMOLOGY

Cabinets for pest proof, insect
specimen storage

**PERMANENT
SPECIMEN
PROTECTION**

225 West 34th Street
9th Floor
New York, NY 10122

212.563.0663 tel
212.465.9440 fax
www.lanescience.com

ABOUT LANE SCIENCE EQUIPMENT

Lane Science Equipment has been a leader in the field of preservation for over fifty years. Our cabinets have been the first choice of museums, universities, and individual collectors all over the world. Customers want, and get, equipment of excellent quality and rugged construction designed for substantial use.

In addition, by providing customers with the highest quality service and rapid response time, we demonstrate our loyalty and respect for you and your collections. We understand your needs. We care about your collections and we want to show you how Lane can best serve you.

**FOR ADDITIONAL INFORMATION ON
LANE SPECIMEN CABINETS PLEASE CONTACT:**

**Lane Science Equipment Corp.
225 West 34th Street
New York, NY 10122-1496
Tel: 212-563-0663
Fax: 212-465-9440**

**Visit our Web Page at
www.lanescience.com**